

Approval body for construction products
and types of construction

Bautechnisches Prüfamt

An institution established by the Federal and
Laender Governments



European Technical Assessment

ETA-19/0573
of 13 July 2023

English translation prepared by DIBt - Original version in German language

General Part

Technical Assessment Body issuing the
European Technical Assessment:

Deutsches Institut für Bautechnik

Trade name of the construction product

FIX-M / FIX-PA / FIX-S / FIX-M-K / FIX-PA-K / FIX-S-K

Product family
to which the construction product belongs

Plastic anchor for fixing of external thermal insulation
composite systems with rendering

Manufacturer

ZIEL-PLAST
Zielinscy Spolka Komandytowa
ul. Zamkowa 28
32-652 BULOWICE
POLEN

Manufacturing plant

ZIEL-PLAST
Zielinscy Spolka Komandytowa
ul. Zamkowa 28
32-652 BULOWICE
POLAND

This European Technical Assessment
contains

23 pages including 3 annexes which form an integral part
of this assessment

This European Technical Assessment is
issued in accordance with Regulation (EU)
No 305/2011, on the basis of

EAD 330196-01-0604, edition 10/2017

This version replaces

ETA-19/0573 issued on 17 January 2020

The European Technical Assessment is issued by the Technical Assessment Body in its official language. Translations of this European Technical Assessment in other languages shall fully correspond to the original issued document and shall be identified as such.

Communication of this European Technical Assessment, including transmission by electronic means, shall be in full. However, partial reproduction may only be made with the written consent of the issuing Technical Assessment Body. Any partial reproduction shall be identified as such.

This European Technical Assessment may be withdrawn by the issuing Technical Assessment Body, in particular pursuant to information by the Commission in accordance with Article 25(3) of Regulation (EU) No 305/2011.

Specific Part

1 Technical description of the product

The nailed-in anchor FIX-M / FIX-PA / FIX-S / FIX-M-K / FIX-PA-K / FIX-S-K consists of a plastic sleeve made of polypropylene (virgin material), a plate and an accompanying specific nail made of glass fibre reinforced polyamide (virgin material) or galvanized steel.

The anchor may in addition be combined with the slip-on-plate TDW 90, TDW 110 and TDW 130.

The product description is given in Annex A.

2 Specification of the intended use in accordance with the applicable European Assessment Document

The performances given in Section 3 are only valid if the anchor is used in compliance with the specifications and conditions given in Annex B.

The verification and assessment methods on which this European Technical Assessment is based lead to the assumption of a working life of the anchor of at least 25 years. The indications given on the working life cannot be interpreted as a guarantee given by the producer, but are to be regarded only as a means for choosing the right products in relation to the expected economically reasonable working life of the works.

3 Performance of the product and references to the methods used for its assessment

3.1 Safety and accessibility in use (BWR 4)

Essential characteristic	Performance
Characteristic load bearing capacity <ul style="list-style-type: none"> - Characteristic resistance under tension load - Minimum edge distance and spacing 	See Annex C 1 – C 2 See Annex B 2
Displacements	See Annex C 3 – C 4
Plate stiffness	See Annex C 3

3.2 Energy economy and heat retention (BWR 6)

Essential characteristic	Performance
Point thermal transmittance	See Annex C 5

4 Assessment and verification of constancy of performance (AVCP) system applied, with reference to its legal base

In accordance with EAD No. 330196-01-0604, the applicable European legal act is: [97/463/EC].

The system to be applied is: 2+

5 Technical details necessary for the implementation of the AVCP system, as provided for in the applicable EAD

Technical details necessary for the implementation of the AVCP system are laid down in the control plan deposited with Deutsches Institut für Bautechnik.

Issued in Berlin on 13 July 2023 by Deutsches Institut für Bautechnik

Dipl.-Ing. Beatrix Wittstock
Head of Section

beglaubigt:
Ziegler

Product FIX-M / FIX-PA / FIX-S

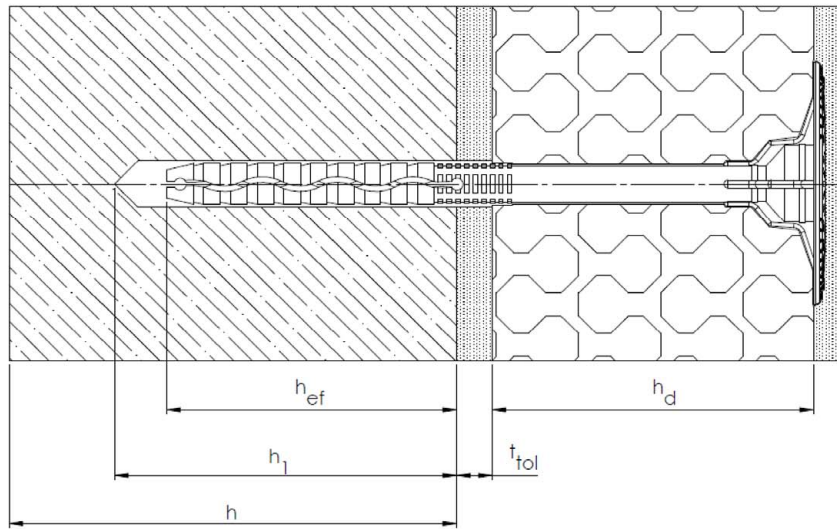

SURFACE MOUNT

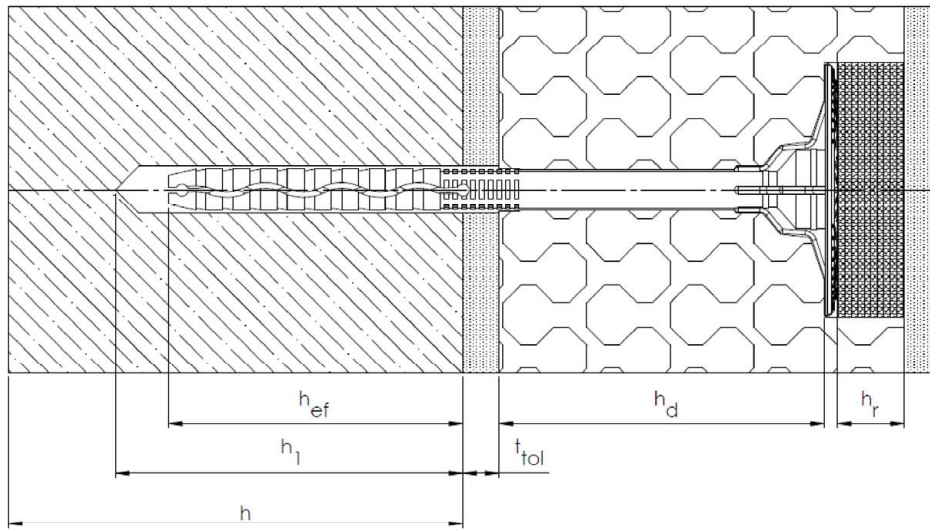

IMMERGED MOUNT

- Legend:
- h_d = thickness of insulation material
 - h_{ef} = effective anchorage depth
 - h = thickness of member (wall)
 - h_1 = depth of drilled hole to deepest point
 - t_{tol} = thickness of equalizing layer or non-load-bearing coating
 - h_r = thickness of insulation cover

FIX-M / FIX-PA / FIX-S / FIX-M-K / FIX-PA-K / FIX-S-K

Product description

Installed condition – surface mount, immersed mount FIX-M / FIX-PA / FIX-S

Annex A 1

Product FIX-M-K / FIX-PA-K / FIX-S-K

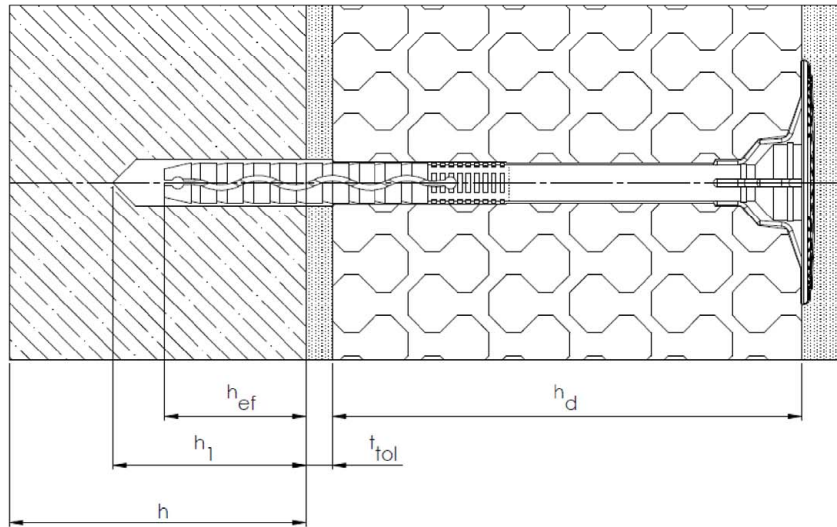

SURFACE MOUNT

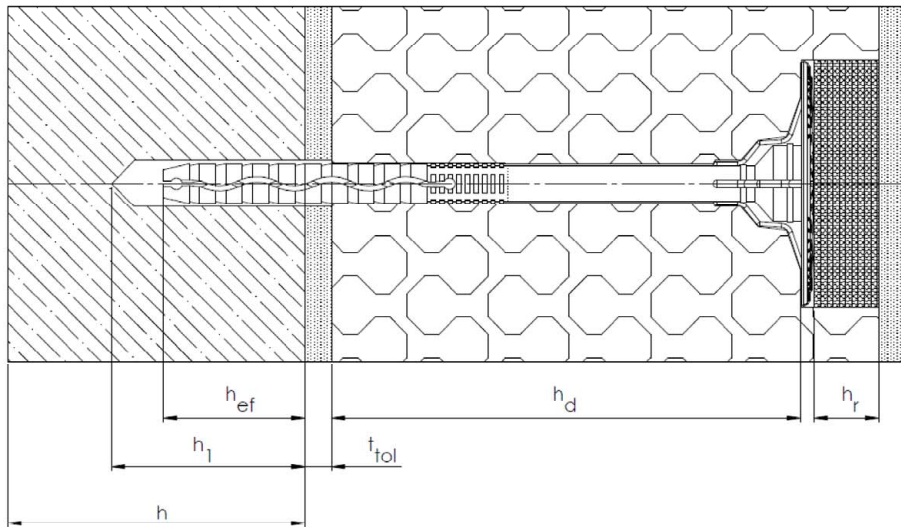

IMMERGED MOUNT

- Legend:
- h_d = thickness of insulation material
 - h_{ef} = effective anchorage depth
 - h = thickness of member (wall)
 - h_1 = depth of drilled hole to deepest point
 - t_{tol} = thickness of equalizing layer or non-load-bearing coating
 - h_r = thickness of insulation cover

FIX-M / FIX-PA / FIX-S / FIX-M-K / FIX-PA-K / FIX-S-K

Product description

Installed condition – surface mount, immersed mount FIX-M-K / FIX-PA-K / FIX-S-K

Annex A 2

FIX-M

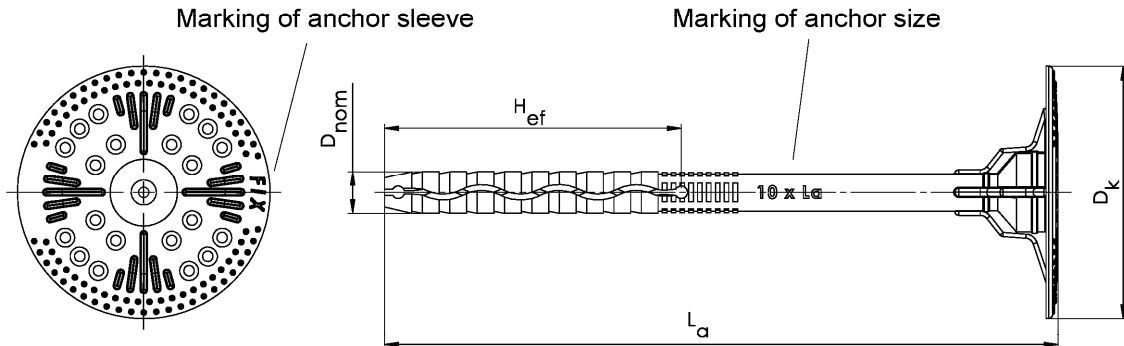

Marking:
Anchor sleeve - FIX
Anchor size - 10 x L_a

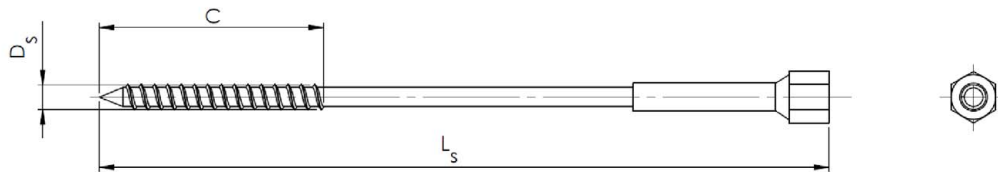

Accompanying specific nail M

Table A1: Dimensions

Anchor Type	Anchor sleeve				Specific nail		
	D _k [mm]	D _{nom} [mm]	H _{ef} [mm]	min L _a max L _a [mm]	D _s [mm]	C [mm]	min L _s max L _s [mm]
FIX-M	60	10	70	100 420	4,4	50	105 425

Determination of maximum thickness of insulation h_d [mm] for FIX-M:

$$h_d = L_a - t_{tol} - H_{ef} \quad (L_a = \text{e.g. } 160; t_{tol} = 10)$$

e.g. $h_d = 160 - 10 - 70 = 80$

FIX-M / FIX-PA / FIX-S / FIX-M-K / FIX-PA-K / FIX-S-K

Product description
FIX-M - marking and dimension of the anchor sleeve FIX
Expansion element M

Annex A 3

FIX-PA

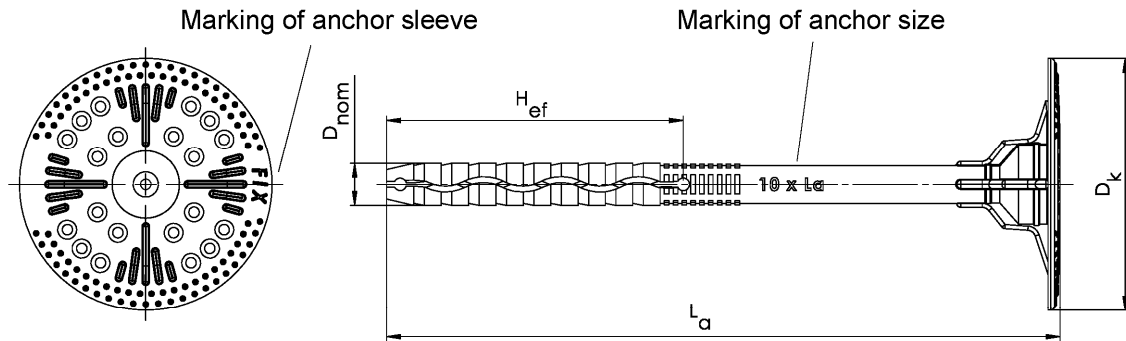

Marking:
Anchor sleeve - FIX
Anchor size - 10xL_a

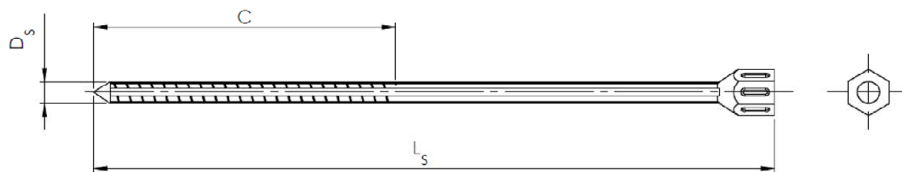

Accompanying specific nail PA

Table A2: Dimensions

Anchor Type	Anchor sleeve				Specific nail		
	D _k [mm]	D _{nom} [mm]	H _{ef} [mm]	min L _a max L _a [mm]	D _s [mm]	C [mm]	min L _s max L _s [mm]
FIX-PA	60	10	70	100 420	5,5	65	105 425

Determination of maximum thickness of insulation h_d [mm] for FIX-PA:

$$h_d = L_a - t_{tol} - H_{ef} \quad (L_a = \text{e.g. } 160; t_{tol} = 10)$$

e.g. $h_d = 160 - 10 - 70 = 80$

FIX-M / FIX-PA / FIX-S / FIX-M-K / FIX-PA-K / FIX-S-K

Product description
FIX-PA - marking and dimension of the anchor sleeve FIX
Expansion element PA

Annex A 4

FIX-S

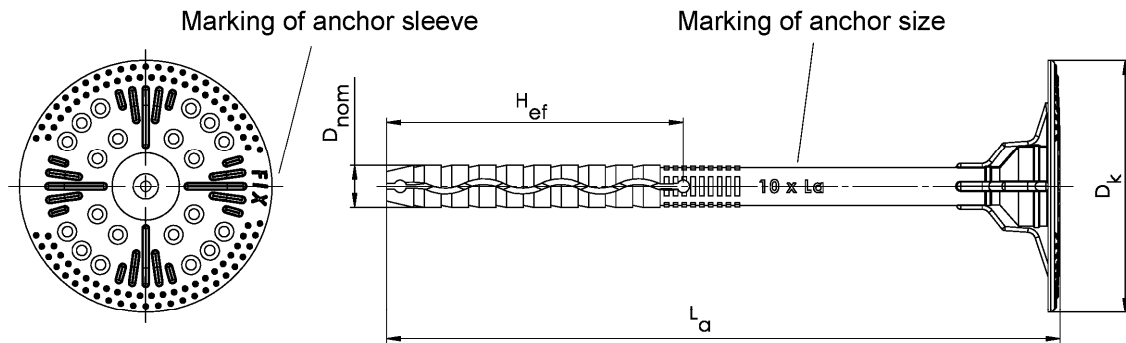

Marking:
Anchor sleeve - FIX
Anchor size - 10xL_d

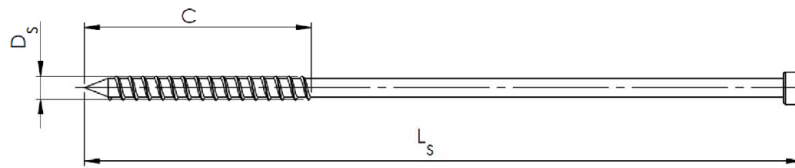

Accompanying specific nail S

Table A3: Dimensions

Anchor Type	Anchor sleeve				Specific nail		
	D _k [mm]	D _{nom} [mm]	H _{ef} [mm]	min L _a max L _a [mm]	D _s [mm]	C [mm]	min L _s max L _s [mm]
FIX-S	60	10	70	100 420	4,4	50	103 423

Determination of maximum thickness of insulation h_d [mm] for FIX-S:

$$h_d = L_a - t_{tol} - H_{ef} \quad (L_a = \text{e.g. } 160; t_{tol} = 10)$$

e.g. $h_d = 160 - 10 - 70 = 80$

FIX-M / FIX-PA / FIX-S / FIX-M-K / FIX-PA-K / FIX-S-K

Product description
FIX-S - marking and dimension of the anchor sleeve FIX
Expansion element S

Annex A 5

FIX-M-K

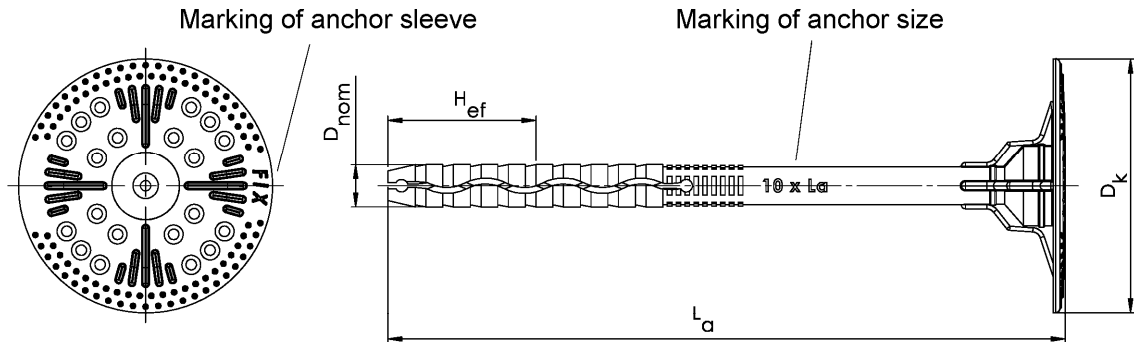

Marking:
Anchor sleeve - FIX
Anchor size – 10 x L_a

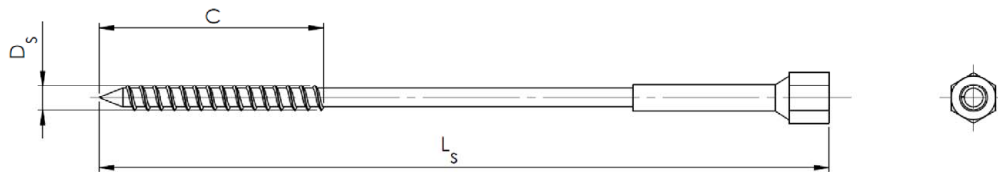

Accompanying specific nail M

Table A4: Dimensions

Anchor Type	Anchor sleeve				Specific nail		
	D _k [mm]	D _{nom} [mm]	H _{ef} [mm]	min L _a max L _a [mm]	D _s [mm]	C [mm]	min L _s max L _s [mm]
FIX-M-K	60	10	35	100 420	4,4	50	105 425

Determination of maximum thickness of insulation h_d [mm] for FIX-M-K:

$$h_d = L_a - t_{tol} - H_{ef} \quad (L_a = \text{e.g. } 160; t_{tol} = 10)$$

e.g. $h_d = 160 - 10 - 35$
 $h_d = 115$

FIX-M / FIX-PA / FIX-S / FIX-M-K / FIX-PA-K / FIX-S-K

Product description
FIX-M-K - marking and dimension of the anchor sleeve FIX -K
Expansion element M

Annex A 6

FIX-PA-K

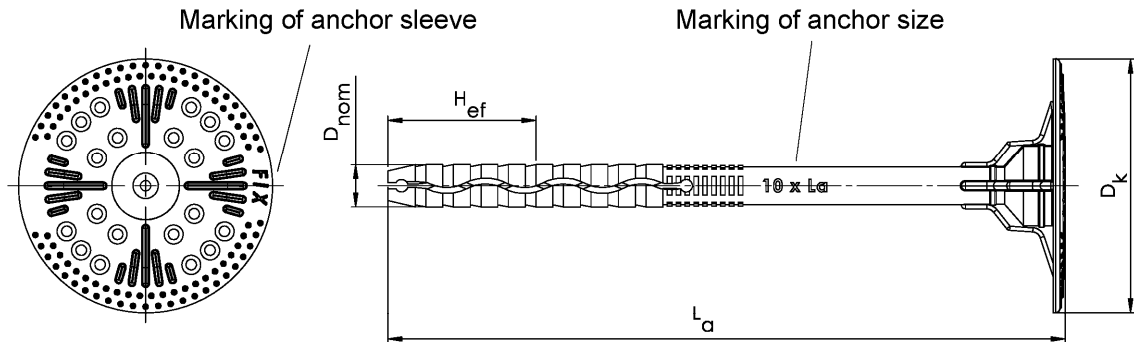

Marking:
Anchor sleeve - FIX
Anchor size - 10 x L_a

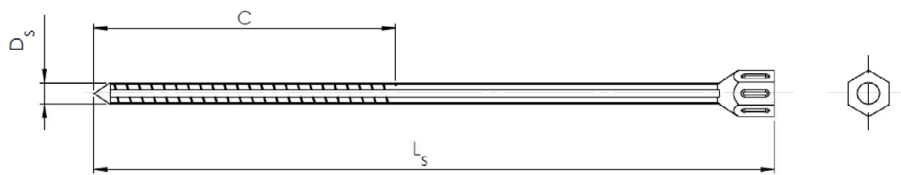

Accompanying specific nail PA

Table A5: Dimensions

Anchor Type	Anchor sleeve				Specific nail		
	D _k [mm]	D _{nom} [mm]	H _{ef} [mm]	min L _a max L _a [mm]	D _s [mm]	C [mm]	min L _s max L _s [mm]
FIX-PA-K	60	10	35	80 420	5,5	65	85 425

Determination of maximum thickness of insulation h_d [mm] for FIX-PA-K:

$$h_d = L_a - t_{tol} - H_{ef} \quad (L_a = \text{e.g. } 160; t_{tol} = 10)$$

e.g. $h_d = 160 - 10 - 35 = 115$

FIX-M / FIX-PA / FIX-S / FIX-M-K / FIX-PA-K / FIX-S-K

Product description

FIX-PA-K - marking and dimension of the anchor sleeve FIX -K
Expansion element PA

Annex A 7

FIX-S-K

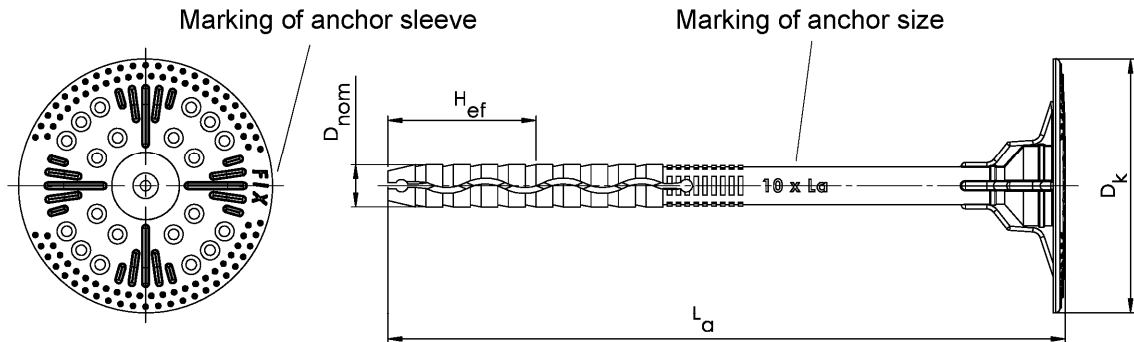

Marking:
Anchor sleeve - FIX
Anchor size - 10 x L_a

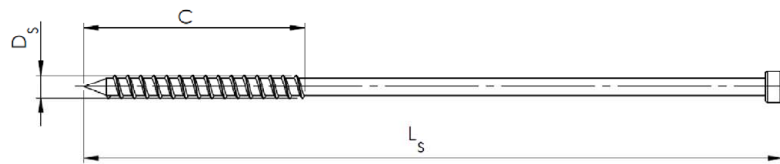

Accompanying specific nail S

Table A6: Dimensions

Anchor Type	Anchor sleeve				Specific nail		
	D _k [mm]	D _{nom} [mm]	H _{ef} [mm]	min L _a max L _a [mm]	D _s [mm]	C [mm]	min L _s max L _s [mm]
FIX-S-K	60	10	35	80 420	4,4	50	83 423

Determination of maximum thickness of insulation h_d [mm] for FIX-S-K:

$$h_d = L_a - t_{tol} - H_{ef} \quad (L_a = \text{e.g. } 160; t_{tol} = 10)$$

e.g. $h_d = 160 - 10 - 35 = 115$

FIX-M / FIX-PA / FIX-S / FIX-M-K / FIX-PA-K / FIX-S-K

Product description
FIX-S-K - marking and dimension of the anchor sleeve FIX -K
Expansion element S

Annex A 8

Table A7: Materials

Name	Materials
Anchor sleeve	virgin Polypropylene, colour: natural
Specific nail M	Carbon steel, electro galvanized $\geq 5 \mu\text{m}$ in accordance with EN ISO 4042:2018, white passivated
Specific nail PA	virgin Polyamide + GF, colour: black
Specific nail S	Carbon steel, electro galvanized $\geq 5 \mu\text{m}$ in accordance with EN ISO 4042:2018, white passivated
Insulation cover	Polystyrene, colour: white or gray

Table A8: Insulation discs, diameters and material

Plate type	$\varnothing D$ [mm]	Material
TDW 90	90	PP, PA
TDW 110	110	PP, PA
TDW 130	130	PP, PA

FIX-M / FIX-PA / FIX-S / FIX-M-K / FIX-PA-K / FIX-S-K

Product description

Materials,
Slip on plates with Product FIX-M / FIX-PA / FIX-S / FIX-M-K / FIX-PA-K / FIX-S-K

Annex A 9

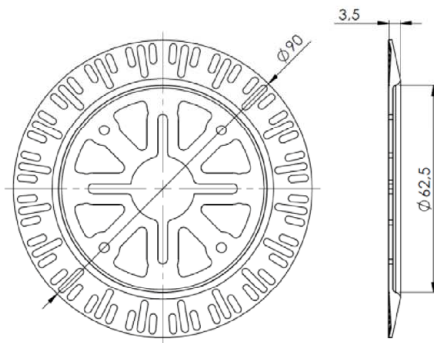

TDW 90

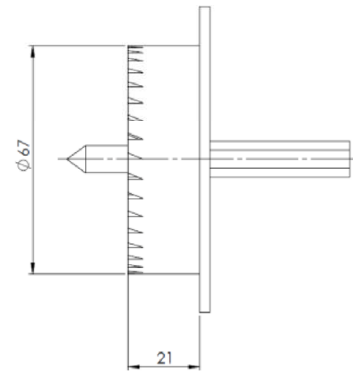

Drill tool ZP-FS for immersed installation

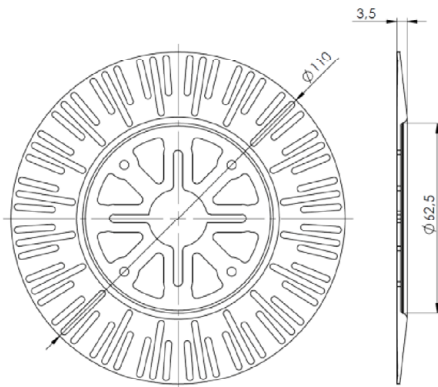

TDW 110

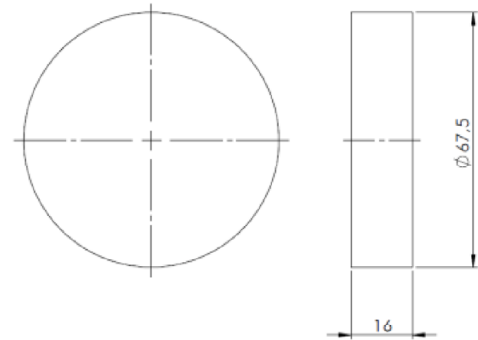

Insulation cover

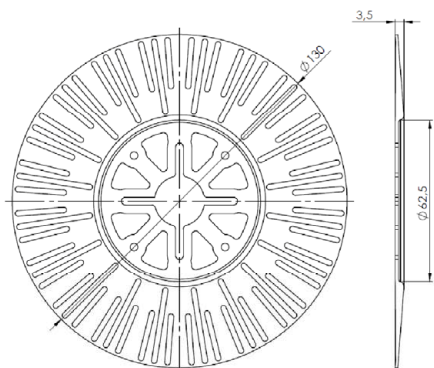

TDW 130

FIX-M / FIX-PA / FIX-S / FIX-M-K / FIX-PA-K / FIX-S-K

Product description

Slip on plates with Product FIX-M / FIX-PA / FIX-S / FIX-M-K / FIX-PA-K / FIX-S-K
Drill tool for immersed installation

Annex A 10

Specifications of intended use

Anchorage subject to:

- The anchor may only be used for transmission of wind suction loads and shall not be used for the transmission of dead loads of the thermal insulation composite system.

Base materials:

- Compacted normal weight concrete without fibres (base material group A) according to Annex C 1
- Solid masonry (base material group B), according to Annex C 1
- Hollow or perforated masonry (base material group C), according to Annex C 1
- Lightweight aggregate concrete (base material group D), according to Annex C 1
- Autoclaved aerated concrete (base material group E), according to Annex C 1
- For other base materials of the base material groups A, B, C, D or E the characteristic resistance of the anchor may be determined by job site tests according to EOTA Technical Report TR 051 edition April 2018.

Temperature Range:

- 0°C to +40°C (max. short term temperature +40°C and max. long term temperature +24°C)

Design:

- The anchorages are designed under the responsibility of an engineer experienced in anchorages and masonry work with the partial safety factors $\gamma_M = 2,0$ and $\gamma_F = 1,5$, if there are no other national regulations.
- Verifiable calculation notes and drawings are prepared taking account of the loads to be anchored. The position of the anchor is indicated on the design drawings.
- Fasteners are only to be used for multiple fixings of thermal insulation composite systems.

Installation:

- Hole drilling by the drill modes according to Annex C 1
- Anchor installation carried out by appropriately qualified personnel and under the supervision of the person responsible for technical matters of the site.
- Installation temperature from 0°C to +40°C
- Exposure to UV due to solar radiation of the anchor not protected by rendering ≤ 6 weeks

FIX-M / FIX-PA / FIX-S / FIX-M-K / FIX-PA-K / FIX-S-K

Intended use
Specifications

Annex B 1

Table B1: Installation parameters for FIX-M / FIX-PA / FIX-S

Anchor type		Product FIX-M / FIX-PA / FIX-S	
		A B C	D and E
Drill hole diameter	d_0 [mm] =	10	10
Cutting diameter of drill bit	d_{cut} [mm] ≤	10,45	10,45
Depth of drilled hole to deepest point	h_1 [mm] ≥	75	75
Effective anchorage depth	h_{ef} [mm] ≥	70	70

Table B2: Installation parameters for FIX-M-K / FIX-PA-K / FIX-S-K

Anchor type		Product FIX-M-K / FIX-PA-K / FIX-S-K	
		A B C	D and E
Drill hole diameter	d_0 [mm] =	10	10
Cutting diameter of drill bit	d_{cut} [mm] ≤	10,45	10,45
Depth of drilled hole to deepest point	h_1 [mm] ≥	40	40
Effective anchorage depth	h_{ef} [mm] ≥	35	35

Table B3: Anchor distances and dimensions of members

Minimum spacing	$s_{min} \geq$ [mm]	100
Minimum edge distance	$c_{min} \geq$ [mm]	100
Minimum thickness of member	$h \geq$ [mm]	100

Scheme of distance and spacing

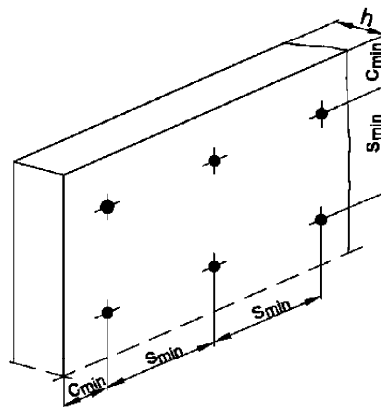

FIX-M / FIX-PA / FIX-S / FIX-M-K / FIX-PA-K / FIX-S-K

Intended use
Installations parameters,
Edge distances and spacing

Annex B 2

Installation instructions

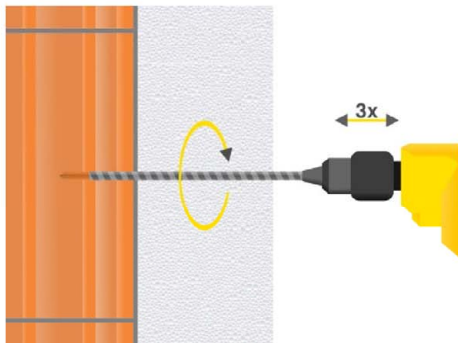

Drill the hole perpendicular to the substrate surface.
Clean the drill hole.

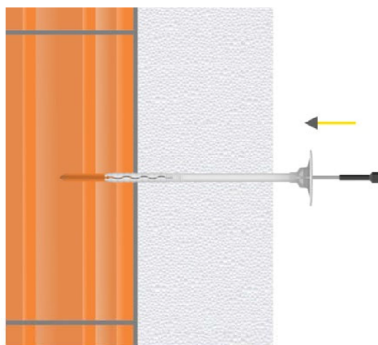

Place the anchor into the drill hole.
The bottom side of the plate must be flush with the ETICS.

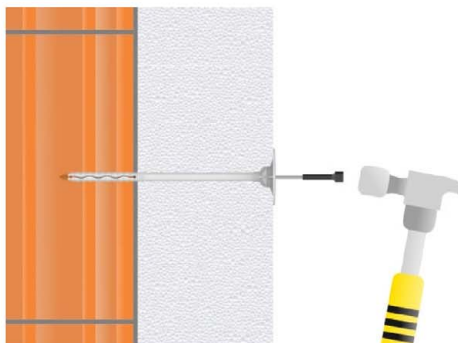

Drive in the specific nail with the hammer.

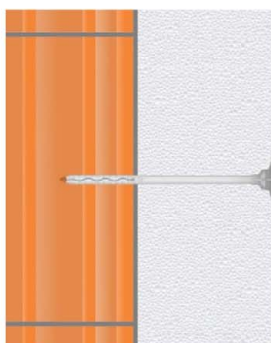

Installed condition.

FIX-M / FIX-PA / FIX-S / FIX-M-K / FIX-PA-K / FIX-S-K

Intended use
Installation instructions – surface mount

Annex B 3

Installation instructions

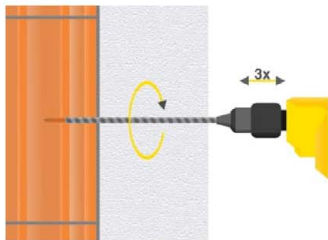

Drill the hole perpendicular to the substrate surface.
Clean the drill hole.

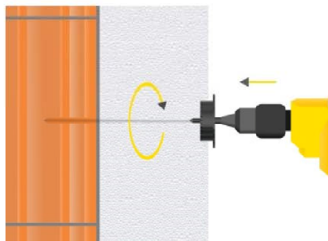

Drill the recess for immersed installation with the tool ZP-FS.

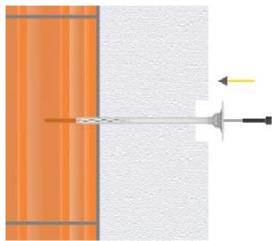

Place the anchor into the drill hole.
The bottom side of the plate must be flush with the ETICS.

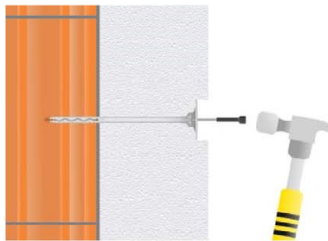

Drive in the specific nail with the hammer.

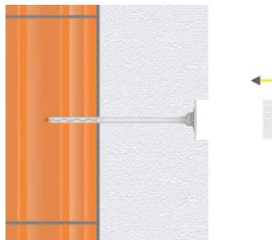

Insert the insulation cover.

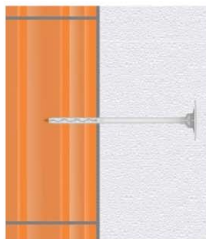

Installed condition.

FIX-M / FIX-PA / FIX-S / FIX-M-K / FIX-PA-K / FIX-S-K

Intended use
Installation instructions – immersed mount

Annex B 4

Table C1: Characteristic resistance to tension loads N_{Rk} in concrete and masonry for a single anchor in kN						
Anchor type					FIX-PA	FIX-PA-K
Base materials	Bulk density ρ [kg/dm ³]	Compressive strength f_b [N/mm ²]	General remarks	Drill method	N_{Rk} [kN]	N_{Rk} [kN]
Concrete C12/15 EN 206:2013+A1:2016	≥ 2,25	≥ 15		hammer	- ¹⁾	0,70
Concrete C16/20 + C50/60 EN 206:2013+A1:2016	≥ 2,30	≥ 25		hammer	- ¹⁾	1,00
Clay bricks, Mz e.g. according to EN 771-1:2011+A1:2015	≥ 2,00	≥ 20		hammer	0,60	0,50
Calcium silicate bricks, KS e.g. according to EN 771-2:2011+A1:2015	≥ 2,00	≥ 20		hammer	0,60	0,50
Calcium silicate perforated bricks, KSL e.g. according to EN 771-2:2011+A1:2015	≥ 1,60	≥ 12	Vertically perforation more than 15 %, outer web thickness ≥ 20 mm	hammer	0,60	0,50
Vertically perforated clay bricks, HLZ e.g. according to EN 771-1:2011+A1:2015	≥ 1,20	≥ 12	Vertically perforation more than 15 % and less than 50 %, outer web thickness ≥ 12 mm	rotary	0,25	0,50
Vertical perforated clay bricks, Porothersm 25 e.g. according to EN 771-1:2011+A1:2015	≥ 0,80	≥ 10	Vertically perforation more than 15 % and less than 50 %, outer web thickness ≥ 12 mm	rotary	0,20	0,20
Autoclaved aerated concrete e.g. according to EN 771-4:2011+A1:2015	≥ 0,35	≥ 2		rotary	0,50	0,45
Lightweight aggregate concrete, LAC e.g. according to EN 1520:2011 / EN 771-3:2011+A1:2015	≥ 0,88	≥ 5		rotary	- ¹⁾	1,00
¹⁾ no performance assessed						
FIX-M / FIX-PA / FIX-S / FIX-M-K / FIX-PA-K / FIX-S-K					Annex C 1	
Performances Characteristic resistance FIX-PA / PIX-PA-K						

Table C2: Characteristic resistance to tension loads N_{Rk} in concrete and masonry for a single anchor in kN						
Anchor type					FIX-M and FIX-S	FIX-M-K and FIX-S-K
Base materials	Bulk density ρ [kg/dm ³]	Compressive strength f_b [N/mm ²]	General remarks	Drill method	N_{Rk} [kN]	N_{Rk} [kN]
Concrete C12/15 EN 206:2013+A1:2016	≥ 2,25	≥ 15		hammer	0,50	0,40
Concrete C16/20 + C50/60 EN 206:2013+A1:2016	≥ 2,30	≥ 25		hammer	0,70	0,55
Clay bricks, Mz e.g. according to EN 771-1:2011+A1:2015	≥ 2,00	≥ 20		hammer	0,45	0,45
Calcium silicate bricks, KS e.g. according to EN 771-2:2011+A1:2015	≥ 2,00	≥ 20		hammer	0,45	0,45
Calcium silicate perforated bricks, KSL e.g. according to EN 771-2:2011+A1:2015	≥ 1,60	≥ 12	Vertically perforation more than 15 %, outer web thickness ≥ 20 mm	hammer	0,45	0,45
Vertically perforated clay bricks, HLz e.g. according to EN 771-1:2011+A1:2015	≥ 1,20	≥ 12	Vertically perforation more than 15 % and less than 50 %, outer web thickness ≥ 12 mm	rotary	0,25	0,25
Vertical perforated clay bricks, Porotherm 25 e.g. according to EN 771-1:2011+A1:2015	≥ 0,80	≥ 10	Vertically perforation more than 15 % and less than 50 %, outer web thickness ≥ 12 mm	rotary	0,10	0,10
Autoclaved aerated concrete, e.g. according to EN 771-4:2011+A1:2015	≥ 0,35	≥ 2		rotary	0,35	0,20
Lightweight aggregate concrete, LAC e.g. according to EN 1520:2011 / EN 771-3:2011+A1:2015	≥ 0,88	≥ 5		rotary	0,70	0,55
FIX-M / FIX-PA / FIX-S / FIX-M-K / FIX-PA-K / FIX-S-K					Annex C 2	
Performances Characteristic resistance FIX-M / FIX-S / FIX-M-K / FIX-S-K						

Table C3: Plate stiffness according EOTA Technical Report TR 026:2016-05

anchor type	diameter of the anchor plate [mm]	load resistance of the anchor plate [kN]	plate stiffness [kN/mm]
FIX-PA, FIX-PA-K FIX-M, FIX-M-K, FIX-S, FIX-S-K	60	1,50	0,6

Table C4: Displacements FIX-PA

Base materials	Tension load N [kN]	Displacements $\Delta\delta_N$ [mm]
Clay bricks, Mz 20 (EN 771-1:2011+A1:2015)	0,20	0,33
Calcium silicate bricks KS 20 (EN 771-2:2011+A1:2015)	0,20	0,30
Calcium silicate hollow block KSL 12 (EN 771-1:2011+A1:2015)	0,20	0,26
Vertically perforated clay bricks, HLZ 12 (EN 771-1:2011+A1:2015)	0,10	0,43
Vertically perforated clay bricks, Porotherm 25 (EN 771-2:2011+A1:2015)	0,07	0,48
Autoclaved aerated concrete, AAC 2 – AAC 7 (EN 771-4:2011+A1:2015)	0,17	0,28

Table C5: Displacements FIX-PA-K

Base materials	Tension load N [kN]	Displacements $\Delta\delta_N$ [mm]
Concrete C12/15 (EN 206:2013+A1:2016)	0,23	0,15
Concrete C16/20 – C50/60 (EN 206:2013+A1:2016)	0,30	0,22
Clay bricks, Mz 20 (EN 771-1:2011+A1:2015)	0,17	0,15
Calcium silicate bricks KS 20 (EN 771-2:2011+A1:2015)	0,17	0,15
Calcium silicate hollow block KSL 12 (EN 771-1:2011+A1:2015)	0,17	0,15
Vertically perforated clay bricks, HLZ 12 (EN 771-1:2011+A1:2015)	0,17	0,15
Vertically perforated clay bricks, Porotherm 25 (EN 771-2:2011+A1:2015)	0,07	0,11
Autoclaved aerated concrete, AAC 2 – AAC 7 (EN 771-4:2011+A1:2015)	0,15	0,12
Lightweight aggregate concrete, LAC 5 (EN 1520:2011 / EN 771-3:2011+A1:2015)	0,30	0,22

FIX-M / FIX-PA / FIX-S / FIX-M-K / FIX-PA-K / FIX-S-K

Performances

Plate stiffness, displacements FIX-PA, FIX-PA-K

Annex C 3

Table C6: Displacements FIX-M / FIX-S

Base materials	Tension load N [kN]	Displacements $\Delta\delta_N$ [mm]
Concrete C12/15 (EN 206:2013+A1:2016)	0,17	0,22
Concrete C16/20 – C50/60 (EN 206:2013+A1:2016)	0,23	0,31
Clay bricks, Mz 20 (EN 771-1:2011+A1:2015)	0,15	0,33
Calcium silicate bricks KS 20 (EN 771-2:2011+A1:2015)	0,15	0,33
Calcium silicate hollow block KSL 12 (EN 771-1:2011+A1:2015)	0,15	0,23
Vertically perforated clay bricks, HLZ 12 (EN 771-1:2011+A1:2015)	0,08	0,44
Vertically perforated clay bricks, Porotherm 25 (EN 771-2:2011+A1:2015)	0,03	0,27
Autoclaved aerated concrete, AAC 2 – AAC 7 (EN 771-4:2011+A1:2015)	0,12	0,12
Lightweight aggregate concrete, LAC 5 (EN 1520:2011 / EN 771-3:2011+A1:2015)	0,23	0,25

Table C7: Displacements FIX-M-K / FIX-S-K

Base materials	Tension load N [kN]	Displacements $\Delta\delta_N$ [mm]
Concrete C12/15 (EN 206:2013+A1:2016)	0,13	0,22
Concrete C16/20 – C50/60 (EN 206:2013+A1:2016)	0,18	0,30
Clay bricks, Mz 20 (EN 771-1:2011+A1:2015)	0,15	0,28
Calcium silicate bricks KS 20 (EN 771-2:2011+A1:2015)	0,15	0,28
Calcium silicate hollow block KSL 12 (EN 771-1:2011+A1:2015)	0,15	0,37
Vertically perforated clay bricks, HLZ 12 (EN 771-1:2011+A1:2015)	0,08	0,21
Vertically perforated clay bricks, Porotherm 25 (EN 771-2:2011+A1:2015)	0,03	0,12
Autoclaved aerated concrete, AAC 2 – AAC 7 (EN 771-4:2011+A1:2015)	0,07	0,33
Lightweight aggregate concrete, LAC 5 (EN 1520:2011 / EN 771-3:2011+A1:2015)	0,18	0,24

FIX-M / FIX-PA / FIX-S / FIX-M-K / FIX-PA-K / FIX-S-K

Performances

Displacements FIX-M, FIX-S, FIX-M-K, FIX-S-K

Annex C 4

Table C8: Point thermal transmittance according EOTA Technical Report TR 025:2016-05

Anchor type	Installed condition	Insulation thickness h_D [mm]	Point thermal transmittance χ [W/K]
FIX-M / FIX-M-K	surface mount	20	0,003
		150	0,003
		375	0,002
	immersed mount	40	0,001
		150	0,002
		395	0,002
FIX-PA / FIX-PA-K	surface mount	20	0,001
		150	0
		375	0
	immersed mount	40	0
		150	0
		395	0
FIX-S / FIX-S-K	surface mount	20	0,002
		150	0,003
		375	0,002
	immersed mount	40	0,001
		150	0,002
		395	0,002

FIX-M / FIX-PA / FIX-S / FIX-M-K / FIX-PA-K / FIX-S-K

Performances
Point thermal transmittance

Annex C 5