

Frame fixing Ø10

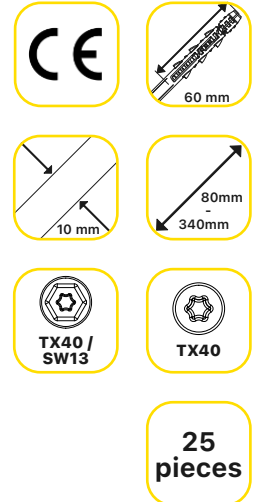
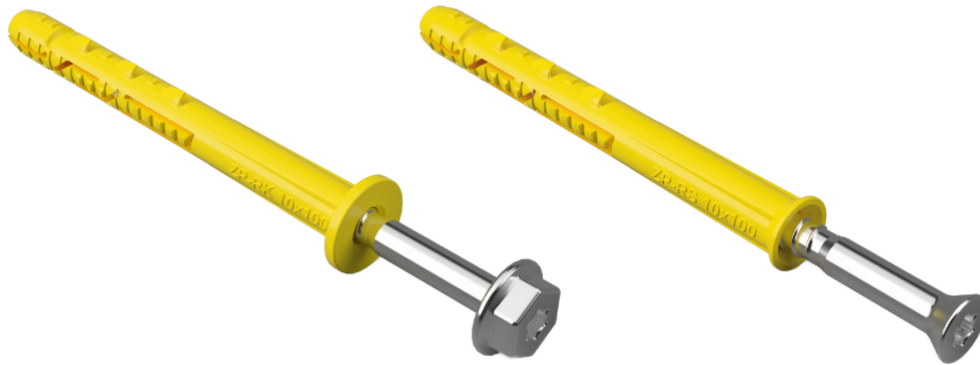

Product description

▶ **European Technical Assessment**
ETA-21/0610

▶ **Material:**
Sleeve - nylon / polyamide
Screw - galvanized steel

▶ **Application:**
recommended for a wide range of applications in building materials with base materials categories: **A, B, C, D.**

The products of the **ZP-RK** and **ZP-RS** series have obtained the European Technical Assessment **ETA-21/0610**, which ensures **the highest quality** that meets the needs of the most demanding customers.

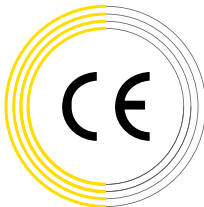

The geometry of the dowel is designed to spread **in many planes.**

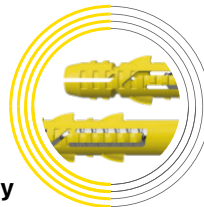

The frame plug with a **large diameter flange** perfectly insulates from the fastened material, thus preventing contact corrosion.

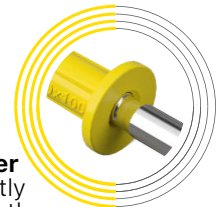

Installation instructions



1. Drill a hole perpendicular to the substrate. Clean the hole.
2. Insert the sleeve into the hole.
3. Screwing the screw into the sleeve of the fastener.
4. The fastener is seated correctly.

Product information

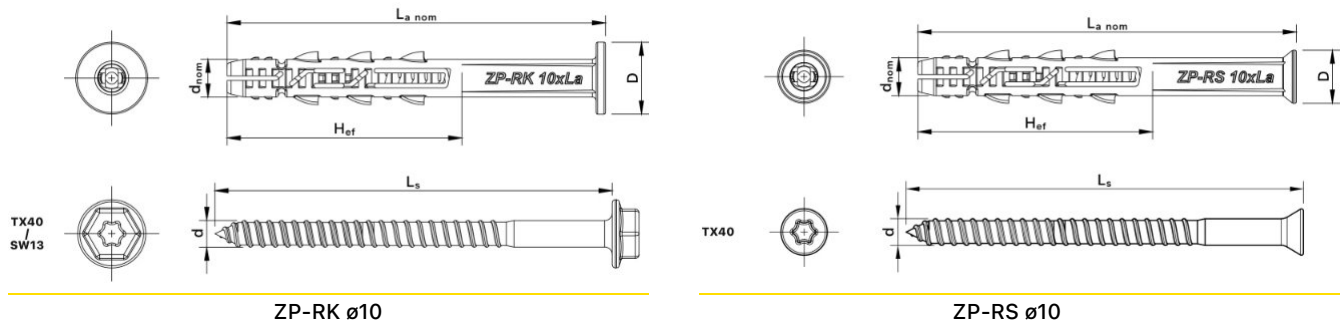

Type	Plug			Screw		Effective anchoring depth H_{ef} [mm]	Mounting hole depth [mm]	Maximum thickness of the fixed element [mm]
	Diameter d_{nom} [mm]	Length $L_{a nom}$ [mm]	Diameter D [mm]	Diameter d [mm]	Length L_s [mm]			
ZP-RK 10x80	10	80	18,5	7,1	85	60	70	20
ZP-RK 10x100	10	100	18,5	7,1	105	60	70	40
ZP-RK 10x120	10	120	18,5	7,1	125	60	70	60
ZP-RK 10x140	10	140	18,5	7,1	145	60	70	80
ZP-RK 10x160	10	160	18,5	7,1	165	60	70	100
ZP-RK 10x180	10	180	18,5	7,1	185	60	70	120
ZP-RK 10x220	10	220	18,5	7,1	225	60	70	160
ZP-RK 10x260	10	260	18,5	7,1	265	60	70	200
ZP-RK 10x300	10	300	18,5	7,1	305	60	70	240
ZP-RK 10x340	10	340	18,5	7,1	345	60	70	280
<hr/>								
ZP-RS 10x80	10	80	14	7,1	85	60	70	20
ZP-RS 10x100	10	100	14	7,1	105	60	70	40
ZP-RS 10x120	10	120	14	7,1	125	60	70	60
ZP-RS 10x140	10	140	14	7,1	145	60	70	80
ZP-RS 10x160	10	160	14	7,1	165	60	70	100
ZP-RS 10x180	10	180	14	7,1	185	60	70	120
ZP-RS 10x220	10	220	14	7,1	225	60	70	160
ZP-RS 10x260	10	260	14	7,1	265	60	70	200
ZP-RS 10x300	10	300	14	7,1	305	60	70	240
ZP-RS 10x340	10	340	14	7,1	345	60	70	280

Characteristic resistance

Base materials	Concrete C12 / 15	Concrete \geq C16/20	Solid clay brick MZ	Solid silicate brick KS	Perforated silicate brick KSL	Vertical perforated clay bricks, Porotherm P+W 25	Autoclaved aerated concrete AAC2	Autoclaved aerated concrete AAC6
Base materials categories								
	A	A	B	B	C	C	D	D
Drilling method								
	hammer	hammer	hammer	hammer	drill	drill	drill	drill
Characteristic resistance [kN]								
$H_{ef} - 60\text{mm}$	5,0	6,0	3,0	3,0	3,0	1,2	0,9	1,6

Base material	$h_{min} \geq$ [mm]	$C_{min} \geq$ [mm]	$S_{min} \geq$ [mm]
Concrete > C16 / 20	100	60	60
Concrete > C12 / 15	100	84	84

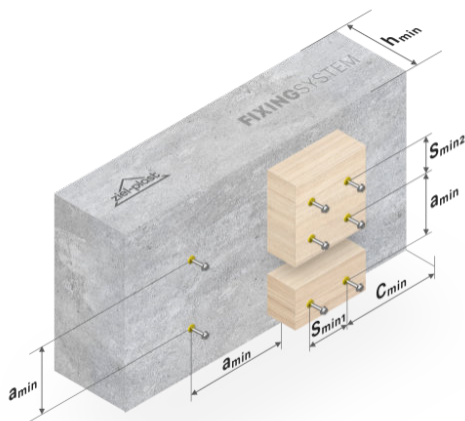

Base material	Single fastener			Fastener in group	
	$h_{min} \geq$ [mm]	$C_{min} \geq$ [mm]	$a_{min} \geq$ [mm]	$S_{min1} \geq$ [mm]	$S_{min2} \geq$ [mm]
Solid clay brick MZ	125	60	250	200	400
Solid silicate brick KS	238	60	250	200	400
Perforated silicate brick KSL	115	60	250	200	400
Vertical perforated clay bricks, Porotherm P+W 25	238	80	250	200	400
Autoclaved aerated concrete AAC2	100	100	250	200	400
Autoclaved aerated concrete AAC6	100	100	250	200	400

Logistics information

Type	Index	Quantity [pcs]		Weight [kg]		EAN code
		Unit package (carton)	Pallet	Unit package (carton)	Pallet	
ZP-RK 10x80	RK10X80	25	11000	0,80	372	5908275918646
ZP-RK 10x100	RK10X100	25	11000	1,00	460	5908275918653
ZP-RK 10x120	RK10X120	25	11000	1,20	555	5908275918660
ZP-RK 10x140	RK10X140	25	7600	1,40	445	5908275918677
ZP-RK 10x160	RK10X160	25	7600	1,60	505	5908275918684
ZP-RK 10x180	RK10X180	25	5400	1,80	409	5907812671396
ZP-RK 10x220	RK10X220	25	5400	2,20	495	5907812671402
ZP-RK 10x260	RK10X260	25	5400	2,60	582	5907812671419
ZP-RK 10x300	RK10X300	25	4400	3,00	548	5907812671426
ZP-RK 10x340	RK10X340	25	4400	3,40	618	5907812671433
ZP-RS 10x80	RS10X80	25	11000	0,74	352	5908275918509
ZP-RS 10x100	RS10X100	25	11000	0,93	434	5908275918516
ZP-RS 10x120	RS10X120	25	11000	1,12	516	5908275918523
ZP-RS 10x140	RS10X140	25	7600	1,30	421	5908275918530
ZP-RS 10x160	RS10X160	25	7600	1,49	477	5908275918547
ZP-RS 10x180	RS10X180	25	5400	1,67	387	5907812671457
ZP-RS 10x220	RS10X220	25	5400	2,05	467	5907812671471
ZP-RS 10x260	RS10X260	25	5400	2,42	547	5907812671891
ZP-RS 10x300	RS10X300	25	4400	2,79	516	5907812671143
ZP-RS 10x340	RS10X340	25	4400	3,16	582	5907812671907